

INTELLIGENT POWER HIGH SIDE SWITCH

Features

- Over temperature shutdown (with auto-restart)
- Short circuit protection (current limit)
- Reverse battery protection (turns On the MOSFET)
- Full diagnostic capability (short circuit to battery)
- Active clamp
- Open load detection in On and Off state
- Ground loss protection
- Logic ground isolated from power ground
- ESD protection

Description

The IPS6031(S)(R)PbF is a five terminal Intelligent Power Switch (IPS) for use in a high side configuration. It features short circuit, over-temperature, ESD protection, inductive load capability and diagnostic feedback. The output current is limited to the I_{lim} value. The current limitation is activated until the thermal protection acts. The over-temperature protection turns off the device if the junction temperature exceeds the T_{shutdown} value. It will automatically restart after the junction has cooled 7°C below the T_{shutdown} value. The reverse battery protection turns On the MOSFET. A diagnostic pin provides different voltage levels for each fault condition. The double level shifter circuitry will allow large offsets between the logic and load ground.

Typical Connection

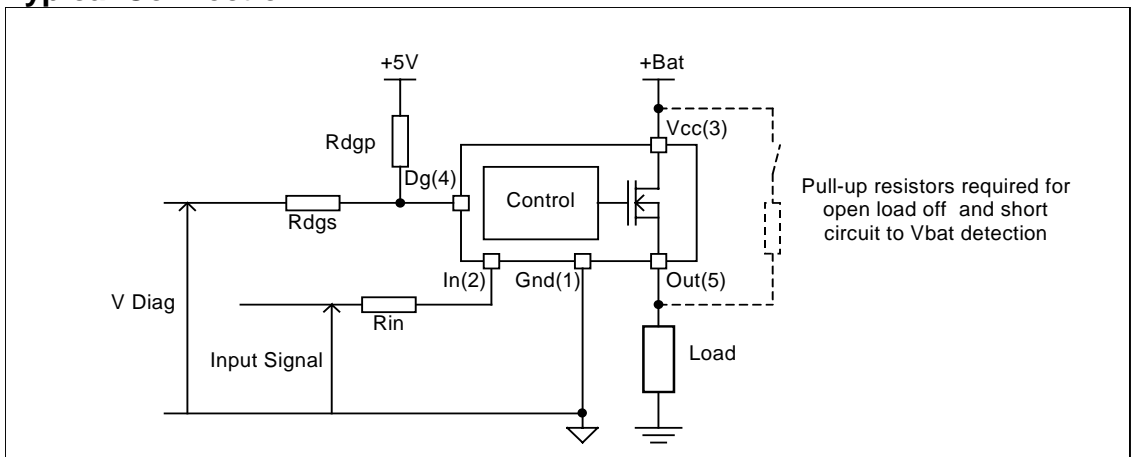

Product Summary

Rds(on)	60mΩ max.
Vclamp	39V
I Limit	16A
Open load	3V / 0.55A

Packages

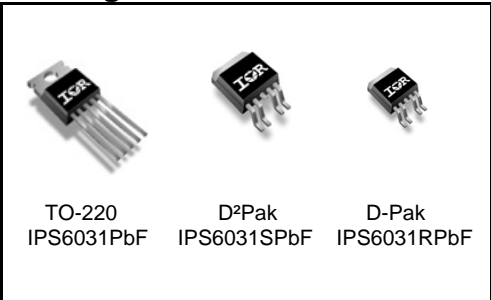

Absolute Maximum Ratings

Absolute maximum ratings indicate sustained limits beyond which damage to the device may occur. All voltage parameters are referenced to Ground lead. (Tambient=25°C unless otherwise specified).

Symbol	Parameter	Min.	Max.	Units	
Vout	Maximum output voltage	Vcc-35	Vcc+0.3	V	
Voffset	Maximum logic ground to load ground offset	Vcc-35	Vcc+0.3		
Vin	Maximum input voltage	-0.3	5.5		
Vcc max.	Maximum Vcc voltage	—	36		
Vcc cont.	Maximum continuous Vcc voltage	—	28		
Vcc sc.	Maximum Vcc voltage with short circuit protection	—	30		
Iin max.	Maximum IN current	-3	10	mA	
I _{dg} max.	Maximum diagnostic output current	-3	10		
V _{dg}	Maximum diagnostic output voltage	-0.3	5.5	V	
Pd	Maximum power dissipation (internally limited by thermal protection) Rth=5°C/W IPS6031	—	25	W	
		Rth=40°C/W IPS6031S 1" sqrt. footprint	—		3.1
		Rth=50°C/W IPS6031R 1" sqrt. footprint	—		2.5
ESD	Electrostatic discharge voltage (Human body) C=100pF, R=1500Ω Between In and Vcc Other combinations	—	1500	V	
		—	4000		
	Electrostatic discharge voltage (Machine Model) C=200pF, R=0Ω, L=10μH Between In and Vcc Other combinations	—	100		
		—	500		
T _j max.	Max. storage & operating temperature junction temperature	-40	150	°C	
T _{soldering}	Soldering temperature (10 seconds)	—	300	°C	

Thermal Characteristics

Symbol	Parameter	Typ.	Max.	Units
Rth1	Thermal resistance junction to ambient IPS6031 TO220 free air	50	—	°C/W
Rth2	Thermal resistance junction to case IPS6031 TO220	3.8	—	
Rth1	Thermal resistance junction to ambient IPS6031S D ² Pak std. footprint	60	—	
Rth2	Thermal resistance junction to ambient IPS6031S D ² Pak 1" sqrt. footprint	40	—	
Rth3	Thermal resistance junction to case IPS6031S D ² Pak	3.8	—	
Rth1	Thermal resistance junction to ambient IPS6031R D-Pak std. footprint	70	—	
Rth2	Thermal resistance junction to ambient IPS6031R D-Pak 1" sqrt. footprint	50	—	
Rth3	Thermal resistance junction to case IPS6031R D-Pak	3.8	—	

Recommended Operating Conditions

These values are given for a quick design. For operation outside these conditions, please consult the application notes.

Symbol	Parameter	Min.	Max.	Units
V _{IH}	High level input voltage	4	5.5	
V _{LIL}	Low level input voltage	0	0.9	
I _{out}	Continuous drain current, Tambient=85°C, T _j =125°C, V _{in} =5V Rth=5°C/W IPS6031 Rth=40°C/W IPS6031S 1" sqrt. footprint Rth=50°C/W IPS6031R 1" sqrt. footprint	—	8.9 3.1 2.8	A
R _{in}	Recommended resistor in series with IN pin	4	10	kΩ
R _{dg} s	Recommended resistor in series with DG pin for reverse battery protection	4	20	
R _{dg} p	Recommended pull-up resistor for DG	4	20	
R _{ol}	Recommended pull-up resistor for open load detection	5	100	
F max.	Max. switching frequency	—	2.5	

Static Electrical Characteristics

T_j=25°C, V_{cc}=14V (unless otherwise specified)

Symbol	Parameter	Min.	Typ.	Max.	Units	Test Conditions
R _{ds(on)}	ON state resistance T _j =25°C	—	46	60	mΩ	V _{in} =5V, I _{out} =5A
	ON state resistance T _j =150°C	—	83	100		V _{in} =5V, I _{out} =5A
	ON state resistance T _j =25°C, V _{cc} =6V	—	55	72		V _{in} =5V, I _{out} =2.5A
	ON state resistance during reverse battery	—	60	80		V _{cc} -Gnd=14V
V _{cc op.}	Operating voltage range	6	—	28	V	
V clamp 1	V _{cc} to Out clamp voltage 1	37	39	—		I _{out} =30mA
V clamp 2	V _{cc} to Out clamp voltage 2	—	40	42		I _{out} =4A (see Fig. 1)
I _{cc Off}	Supply current when Off	—	4	9	μA	V _{in} =0V, V _{out} =0V
I _{cc On}	Supply current when On	—	2.2	5	mA	V _{in} =5V
V _{ih}	Input high threshold voltage	—	2.5	2.9	V	
V _{il}	Input low threshold voltage	1.5	2	—		
I _{n hyst.}	Input hysteresis	0.2	0.5	1		
I _{in On}	Input current when device is On	—	45	100		
I _{dg}	Dg leakage current	—	0.1	10	μA	V _{dg} =5V
V _{dg}	Low level DG voltage	—	0.25	0.4	V	I _{dg} =1.6mA

Switching Electrical Characteristics

V_{cc}=14V, Resistive load=6Ω, V_{in}=5V, T_j=25°C

Symbol	Parameter	Min.	Typ.	Max.	Units	Test Conditions
T _{don}	Turn-on delay time	—	8	25	μs	see Fig. 3
Tr1	Rise time to V _{out} =V _{cc} -5V	—	5	20		
Tr2	Rise time to V _{out} =0.9 x V _{cc}	—	8	35		
dV/dt (On)	Turn On dV/dt	—	1.5	2.5	V/μs	
E _{On}	Turn On energy	—	150	—	μJ	
T _{doff}	Turn-off delay time	—	20	45	μs	
T _f	Fall time to V _{out} =0.1 x V _{cc}	—	9	30		
dV/dt (Off)	Turn Off dV/dt	—	3	10	V/μs	
E _{Off}	Turn Off energy	—	65	—	μJ	

Protection Characteristics

Symbol	Parameter	Min.	Typ.	Max.	Units	Test Conditions
Ilim	Internal current limit	10	16	23	A	Vout=0V
Tsd+	Over temperature high threshold	150(1)	165	—	°C	See fig. 2
Tsd-	Over temperature low threshold	—	158	—		
Vsc	Short-circuit detection voltage(2)	2	3	4		
UV		—	5	5.9	V	
UV hyst.		0.25	—	1.6		
VOL Off	Open load detection threshold	2	3	4		
IOL On	Open load detection threshold	0.15	0.4	0.55	A	

(1) Guaranteed by design

(2) Reference to Vcc

True Table

Operating Conditions	IN	OUT	DG
Normal	H	H	H
Normal	L	L	H
Open Load	H	H	L
Open Load (3)	L	H	L
Short circuit to Gnd	H	L	L
Short circuit to Gnd	L	L	H
Short circuit to Vcc	H	H	L (4)
Short circuit to Vcc (5)	L	H	L
Over-temperature	H	L	L
Over-temperature	L	L	H

(3) With a pull-up resistor connected between the output and Vcc.

(4) Vds lower than 10mV.

(5) Without a pull-up resistor connected between the output and Vcc.

Lead Assignments

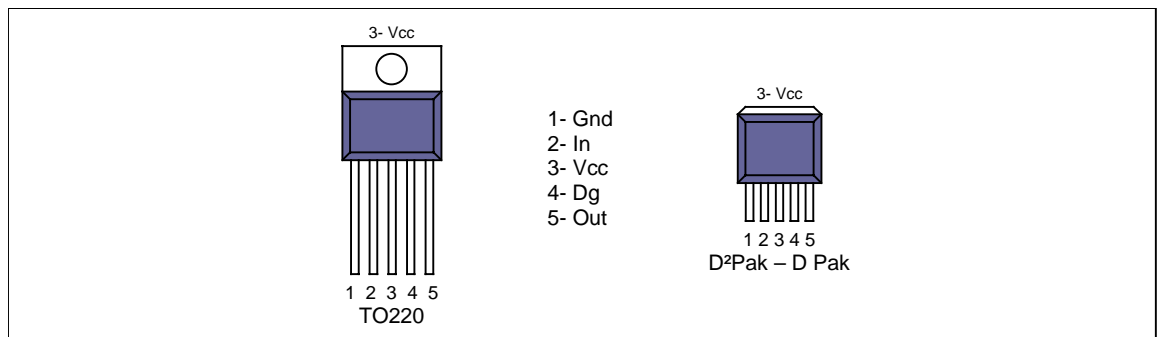



Figure 1 – Active clamp waveforms

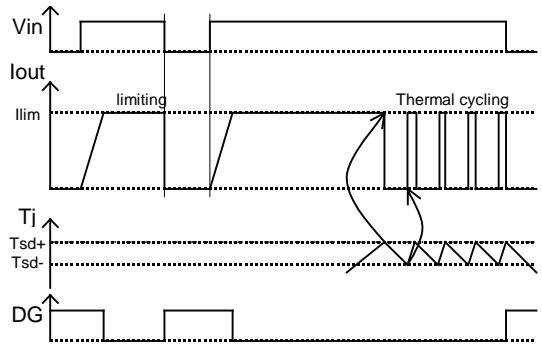

Figure 2 – Protection timing diagram

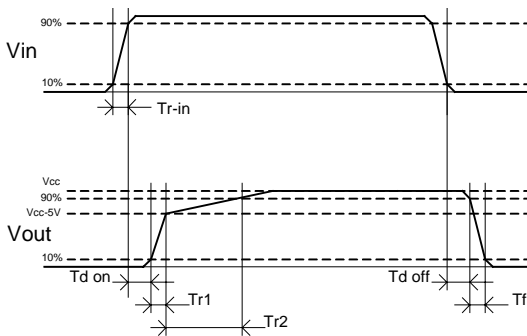

Figure 3 – Switching times definitions



Figure 4 – Active clamp test circuit

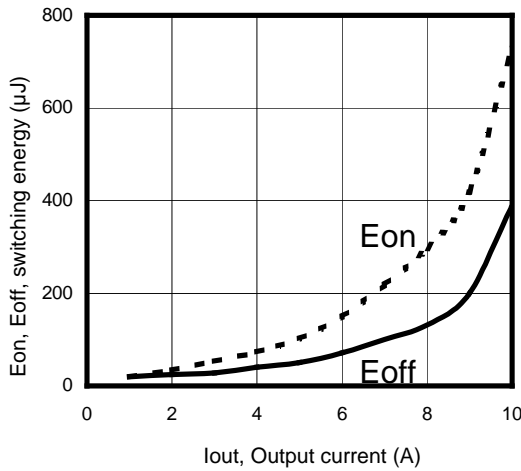

Figure 5 – Switching energy (μJ) Vs Output current (A)

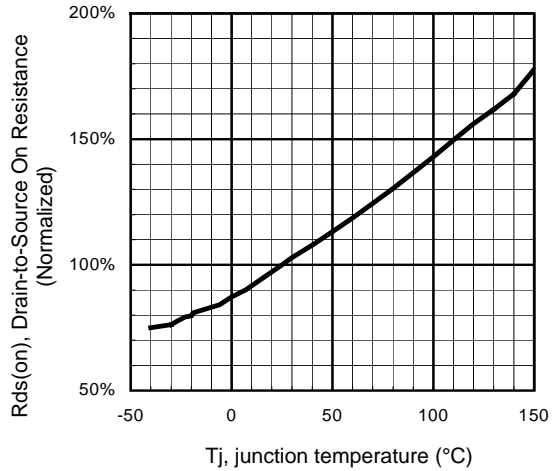

Figure 6 - Normalized R_{ds(on)} (%) Vs T_j (°C)

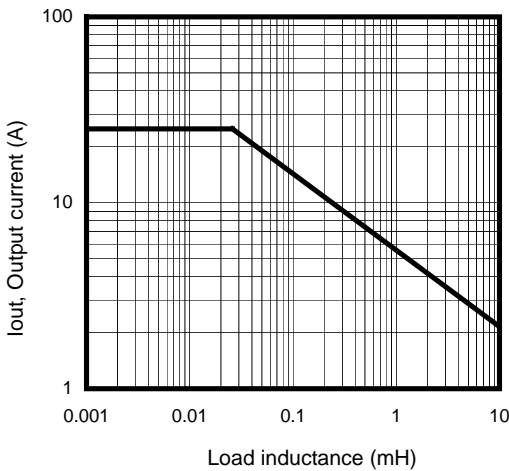

Figure 7 – Max. Output current (A) Vs Load inductance (mH)

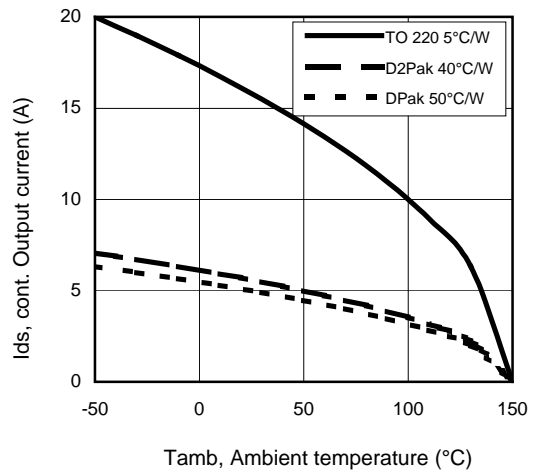

Figure 8 – Max. output current (A) Vs Ambient temperature (°C)

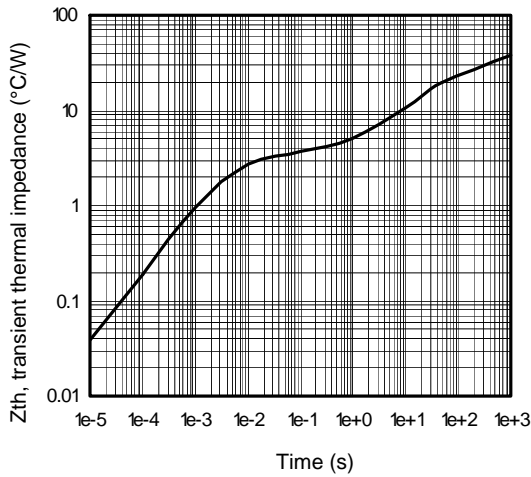

Figure 9 – Transient thermal impedance (°C/W) Vs time (s)

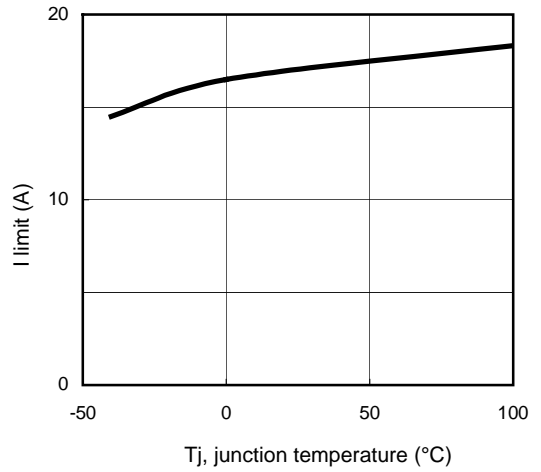

Figure 10 – I limit (A) Vs junction temperature (°C)

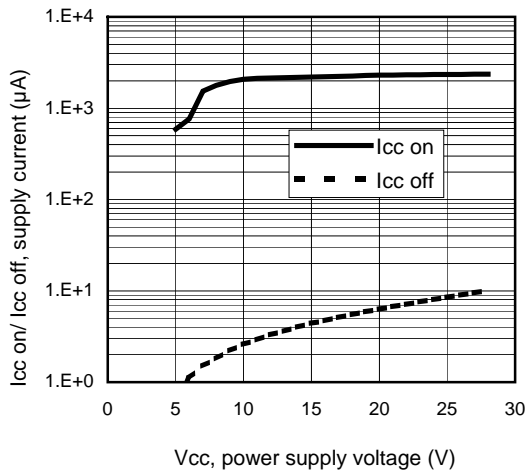

Figure 11 – Icc on/ Icc off (µA) Vs Vcc (V)

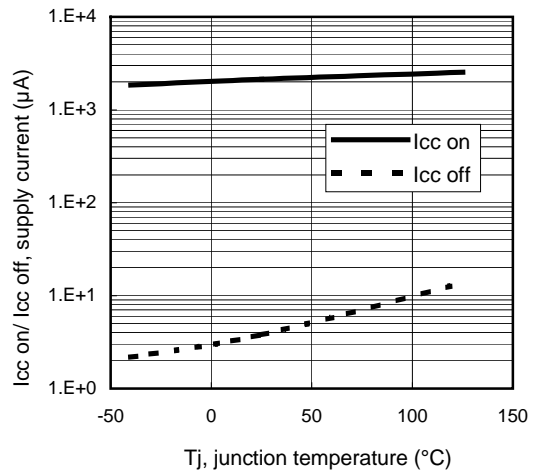
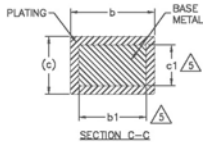
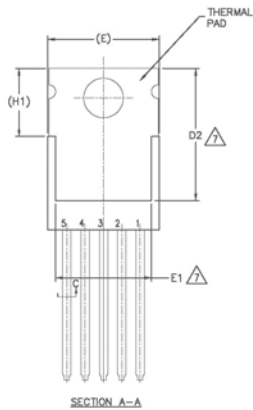
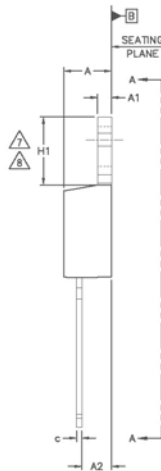
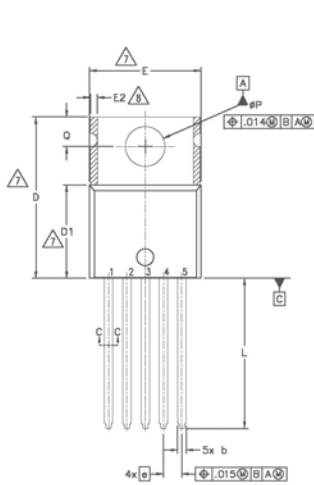

Figure 12 – Icc on/ Icc off (µA) Vs Tj (°C)

Case Outline - TO220 (5 lead) - Automotive Q100 PbF qualified



SYMBOL	DIMENSIONS				NOTES	
	MILLIMETERS		INCHES			
	MIN.	MAX.	MIN.	MAX.		
A	3.56	4.83	.140	.190	5	
A1	0.51	1.40	.020	.055		
A2	2.03	2.92	.080	.115		
b	0.64	0.89	.025	.035		
b1	0.64	0.84	.025	.033		
c	0.36	0.61	.014	.024		
c1	0.36	0.56	.014	.022		
D	14.22	16.51	.560	.650		4
D1	8.38	9.02	.330	.355		7
D2	11.68	12.88	.460	.507		
E	9.65	10.67	.380	.420	4,7	
E1	6.86	8.89	.270	.350	7	
E2	-	0.76	-	.030	8	
e	1.70 BSC		.067 BSC		7,8	
H1	5.84	6.86	.230	.270		
L	12.70	14.73	.500	.580		
ϕP	3.53	3.73	.139	.147		
Q	2.54	3.05	.100	.120		

NOTES:

- 1.- DIMENSIONING AND TOLERANCING AS PER ASME Y14.5 M-1994.
- 2.- DIMENSIONS ARE SHOWN IN INCHES [MILLIMETERS]
- 3.- LEAD DIMENSION AND FINISH UNCONTROLLED IN L1.
- 4.- DIMENSION D, D1 & E DO NOT INCLUDE MOLD FLASH. MOLD FLASH SHALL NOT EXCEED .005" (0.127) PER SIDE. THESE DIMENSIONS ARE MEASURED AT THE OUTERMOST EXTREMES OF THE PLASTIC BODY.
- 5.- DIMENSION b1 & c1 APPLY TO BASE METAL ONLY.
- 6.- CONTROLLING DIMENSION : INCHES.
- 7.- THERMAL PAD CONTOUR OPTIONAL WITHIN DIMENSIONS E,H1,D2 & E1
- 8.- DIMENSION E2 X H1 DEFINE A ZONE WHERE STAMPING AND SINGULATION IRREGULARITIES ARE ALLOWED.
- 9.- OUTLINE CONFORMS TO JEDEC TO-220, EXCEPT A2 (max.) AND D2 (min.) WHERE DIMENSIONS ARE DERIVED FROM THE ACTUAL PACKAGE OUTLINE.
- 10.- LEADS AND DRAIN ARE PLATED WITH 100% Sn

Case Outline 5 Lead - D2PAK - Automotive Q100 PbF MSL1 qualified

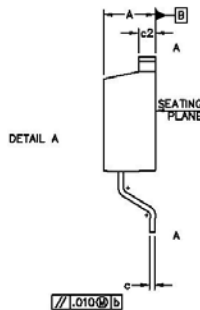
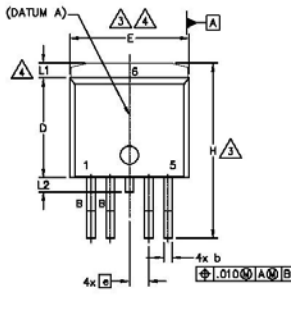
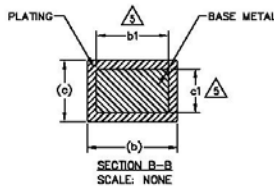
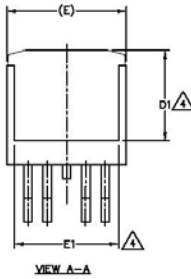
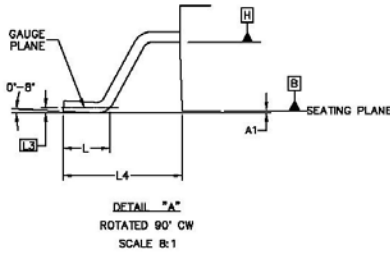

NOTES:

1. DIMENSIONING AND TOLERANCING AS PER ASME Y14.5M-1994
2. DIMENSIONS ARE SHOWN IN MILLIMETERS [INCHES]
3. DIMENSION D & E DO NOT INCLUDE MOLD FLASH. MOLD FLASH SHALL NOT EXCEED 0.127 [.005"] PER SIDE. THESE DIMENSIONS ARE MEASURED AT THE OUTMOST EXTREMES OF THE PLASTIC BODY AT DATUM H.
4. THERMAL PAD CONTOUR OPTIONAL WITHIN DIMENSION E, L1, D1 & E1.
5. DIMENSION b1 AND c1 APPLY TO BASE METAL ONLY.
6. DATUM A & B TO BE DETERMINED AT DATUM PLANE H.
7. CONTROLLING DIMENSION: INCH.
8. OUTLINE CONFORMS TO JEDEC OUTLINE TO-263BA.
9. LEADS AND DRAIN ARE PLATED : 100% Sn

SYM- BO- L	DIMENSIONS				NOTES
	MILLIMETERS		INCHES		
	MIN.	MAX.	MIN.	MAX.	
A	4.06	4.83	.160	.190	
A1	-	0.254	-	.010	
b	0.51	0.99	.020	.039	4
b1	0.51	0.89	.020	.035	
c	0.38	0.74	.015	.029	
c1	0.38	0.58	.015	.023	4
c2	1.14	1.65	.045	.065	
D	8.38	9.65	.330	.380	3
D1	6.86	-	.270	-	
E	9.65	10.87	.380	.420	3
E1	6.22	-	.245	-	
e	1.70 BSC		.067 BSC		
H	14.61	15.85	.575	.625	
L	1.78	2.79	.070	.110	
L1	-	1.68	-	.066	
L2	-	1.78	-	.070	
L3	0.25 BSC		.010 BSC		
L4	4.78	5.28	.188	.208	

Tape & Reel 5 Lead - D2PAK

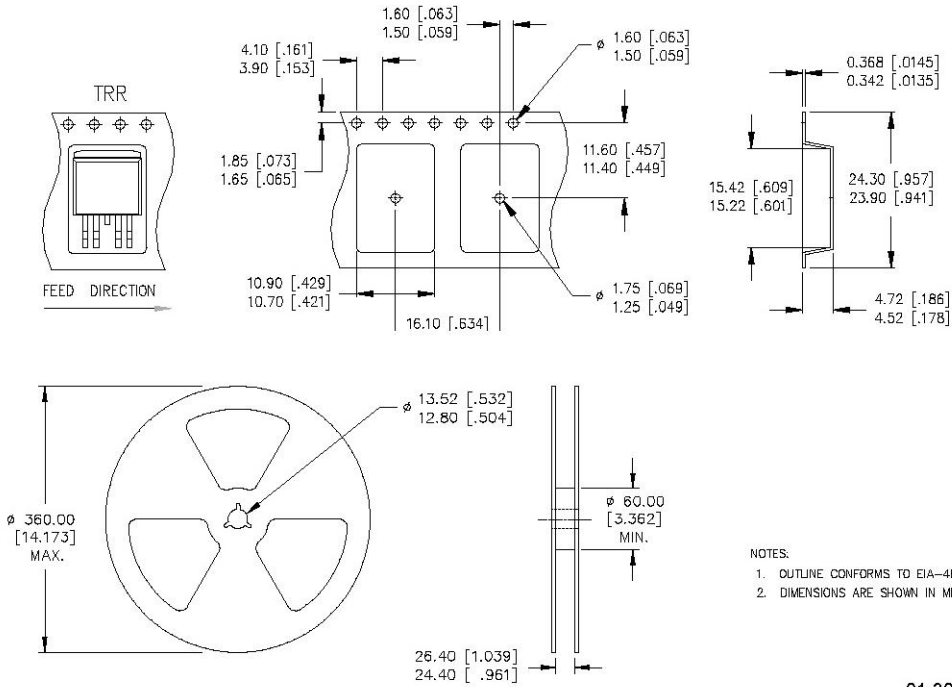

- NOTES:
1. OUTLINE CONFORMS TO EIA-481 & EIA-541.
 2. DIMENSIONS ARE SHOWN IN MILLIMETERS [INCHES].

01-3071 00 / 01-3072 00

Case Outline 5 Lead – DPAK - Automotive Q100 PbF MSL1 qualified

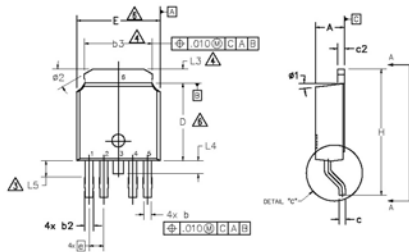
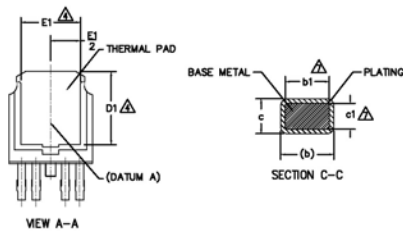
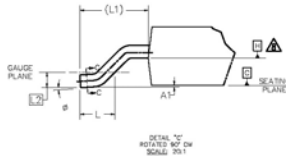

SYMBOLOL	DIMENSIONS				NOTES
	MILLIMETERS		INCHES		
	MIN.	MAX.	MIN.	MAX.	
A	2.18	2.39	.086	.094	
A1	—	0.13	—	.005	
b	0.51	0.89	.020	.035	2
b1	.051	0.84	.020	.033	2
b3	4.95	5.46	.195	.215	
c	0.46	0.61	.018	.024	
c1	0.41	0.56	.016	.022	2
c2	0.46	0.89	.018	.035	
D	5.97	6.22	.235	.245	3
D1	5.21	—	.205	—	
E	6.35	6.73	.250	.265	3
E1	4.32	—	.170	—	
e	1.14 BSC		.045 BSC		
H	9.40	10.41	.370	.410	
L	1.40	1.78	.055	.070	
L1	2.74 BSC		.108 REF.		
L2	0.51 BSC		.020 BSC		
L3	0.89	1.27	.035	.050	
L4	—	1.02	—	.040	
L5	1.14	1.52	.045	.060	
ø	0"	10"	0"	10"	
ø1	0"	15"	0"	15"	
ø2	28"	32"	28"	32"	

NOTES:

- 1.- DIMENSIONING AND TOLERANCING AS PER ASME Y14.5M-1994
- 2.- DIMENSIONS ARE SHOWN IN INCHES [MILLIMETERS].
- 3.- LEAD DIMENSION UNCONTROLLED IN L5.
- 4.- DIMENSION D1, E1, L3 & b3 ESTABLISH A MINIMUM MOUNTING SURFACE FOR THERMAL PAD.
- 5.- SECTION C-C DIMENSIONS APPLY TO THE FLAT SECTION OF THE LEAD BETWEEN .005 AND 0.10 [0.13 AND 0.25] FROM THE LEAD TIP.
- 6.- DIMENSION D & E DO NOT INCLUDE MOLD FLASH. MOLD FLASH SHALL NOT EXCEED .005 [0.13] PER SIDE. THESE DIMENSIONS ARE MEASURED AT THE OUTMOST EXTREMES OF THE PLASTIC BODY.
- 7.- DIMENSION b1 & c1 APPLIED TO BASE METAL ONLY.
- 8.- DATUM A & B TO BE DETERMINED AT DATUM PLANE H.
- 9.- OUTLINE CONFORMS TO JEDEC OUTLINE TO-252.
10. LEADS AND DRAIN ARE PLATED WITH 100% Sn

Tape & Reel 5 Lead – DPAK

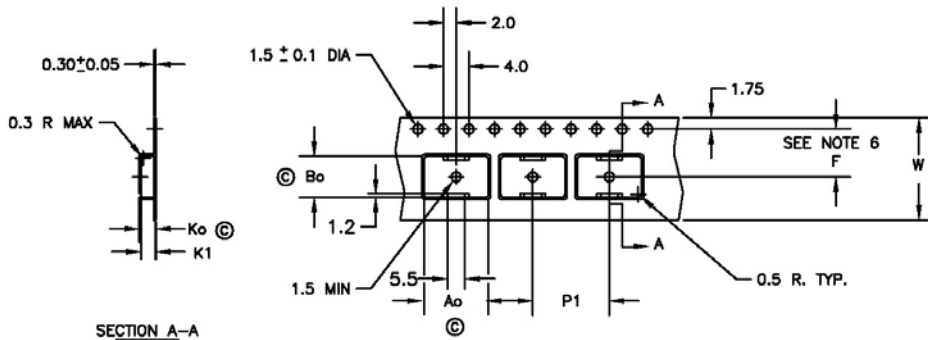

SECTION A-A

$A_o = 10.5 \text{ mm}$
 $B_o = 7.0 \text{ mm}$
 $K_o = 2.8 \text{ mm}$
 $K_1 = 2.4 \text{ mm}$
 $F = 7.5 \text{ mm}$
 $P_1 = 12.0 \text{ mm}$
 $W = 16.0 \pm .3 \text{ mm}$

NOTES:

1. 10 SPROCKET HOLE PUNCH CUMULATIVE TOLERANCE ± 0.02
2. CAMBER NOT TO EXCEED 1mm IN 100mm
3. MATERIAL: CONDUCTIVE BLACK POLYSTYRENE
4. A_o AND B_o MEASURED ON A PLANE 0.3mm ABOVE THE BOTTOM OF THE POCKET
5. K_o MEASURED FROM A PLANE ON THE INSIDE BOTTOM OF THE POCKET TO THE TOP SURFACE OF THE CARRIER
6. POCKET POSITION RELATIVE TO THE SPROCKET HOLE MEASURED AS TRUE POSITION OF POCKET, NOT POCKET HOLE
7. VENDOR: (OPTIONAL)
8. MUST ALSO MEET REQUIREMENTS OF EIA STANDARD #EIA-481A, TAPING OF SURFACE-MOUNT COMPONENTS FOR AUTOMATIC PLACEMENT.
9. TOLERANCE TO BE MANUFACTURER STANDARD
10. SURFACE RESISTIVITY OF MOLDED MATL: MUST MEASURE LESS THAN OR EQUAL TO 10^8 OHMS PER SQUARE. MEASURED IN ACCORDANCE TO PROCEDURE GIVEN IN ASTM D-257 & ASTM D-991 (REF. C-9000 SPEC.)
11. TOTAL LENGTH PER REEL MUST BE 79 METERS
12. © CRITICAL DIMENSION

Note: For the most current drawings please refer to the IR website at:
<http://www.irf.com/package/>